



Intellectual
Property
Office

Certificate of Registration for a UK Design

Design number: 6511787

Grant date: 30 March 2026

Registration date: 11 March 2026

This is to certify that,

in pursuance of and subject to the provision of Registered Designs Act 1949, the design of which a representation or specimen is attached, had been registered as of the date of registration shown above in the name of

Dr. Pramod Raghunath Lawand, Dr. Ashvini Baburao Patil, Dr. Ajay Sarjerao

Nalawade, Mr. Ratan Vikram More, Mr. Atharva Amol Yadav

in respect of the application of such design to:

Automated Plant Growth Observation and Data Recording Device

International Design Classification:

Version: 15-2025

Class: 14 RECORDING, TELECOMMUNICATION OR DATA PROCESSING EQUIPMENT

Subclass: 02 DATA PROCESSING EQUIPMENT AS WELL AS PERIPHERAL APPARATUS AND DEVICES

Adam Williams

Comptroller-General of Patents, Designs and Trade Marks

Intellectual Property Office

The attention of the Proprietor(s) is drawn to the important notes overleaf.



Representation of Designs

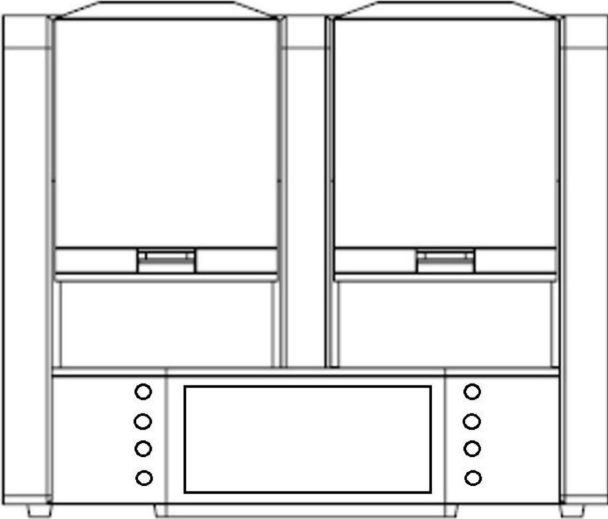
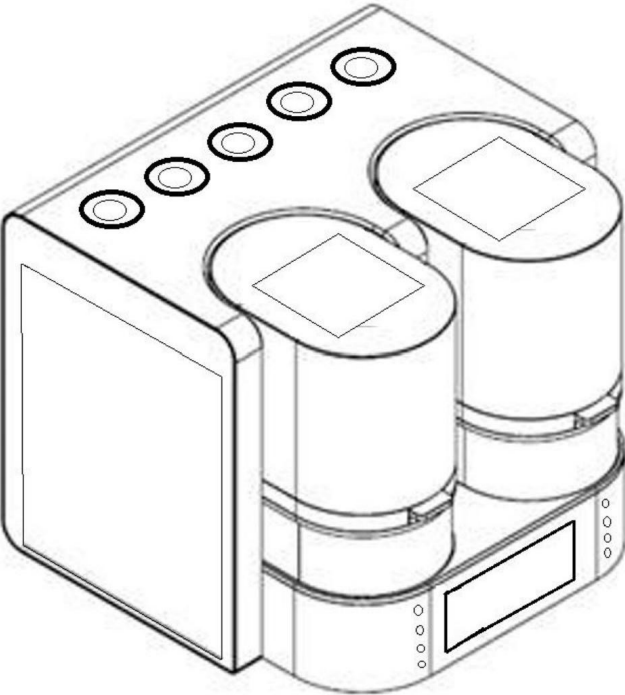

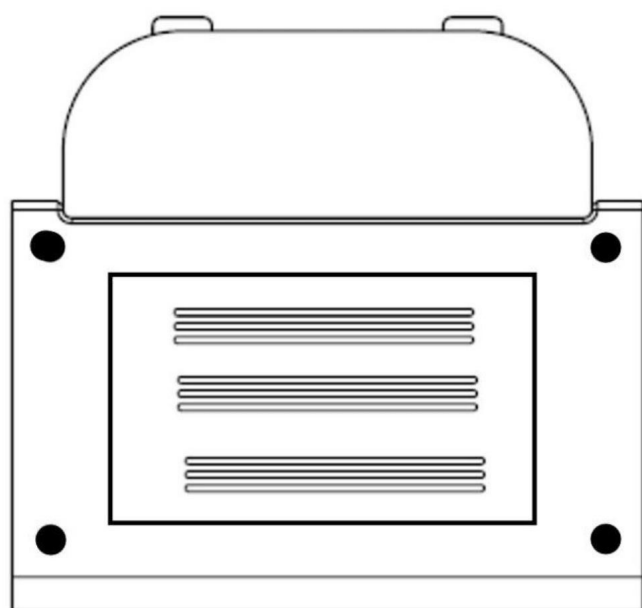
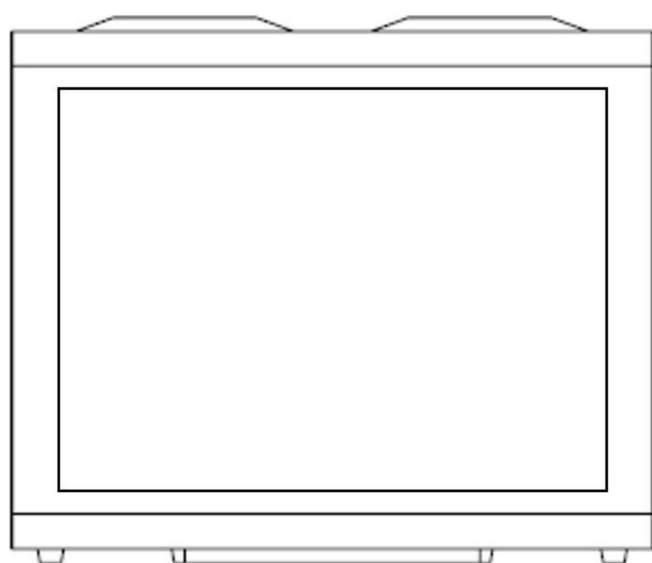

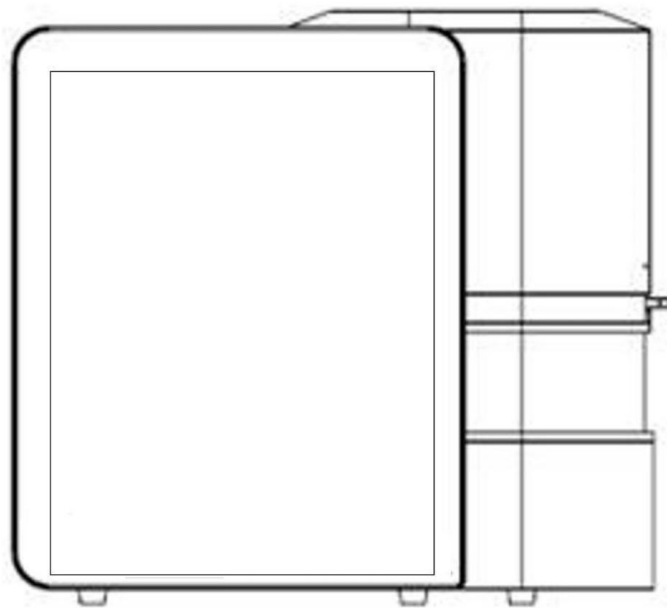
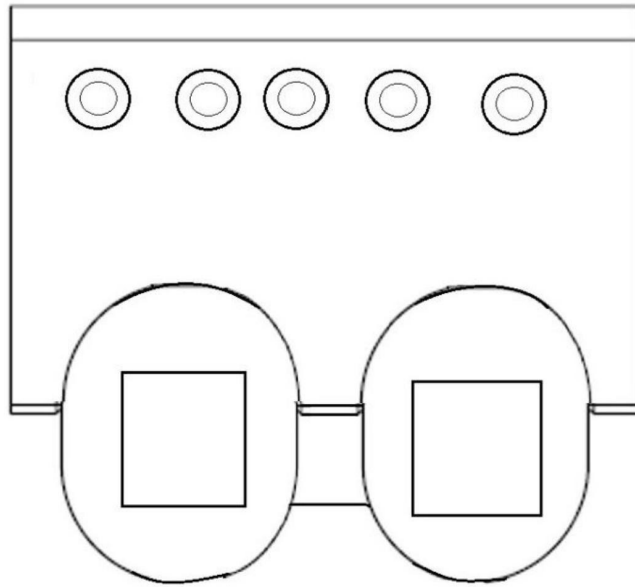

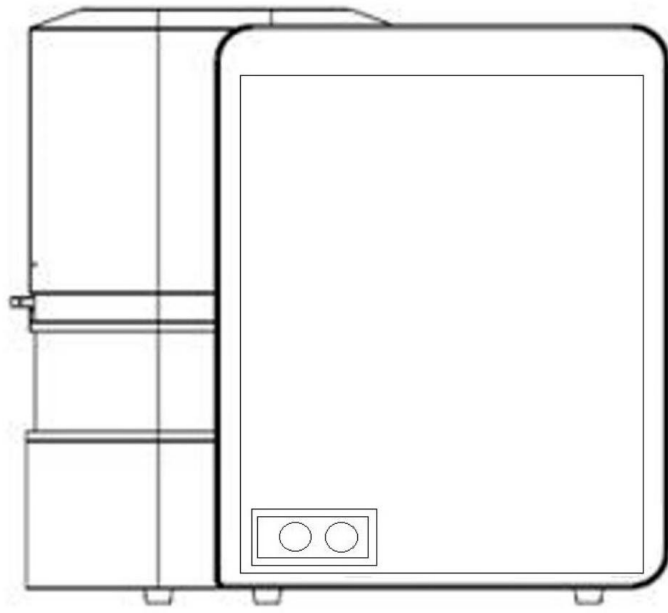

Intellectual Property Office is an operating name of the Patent Office

www.gov.uk/ipo